

RoHS2.0  
Compliant

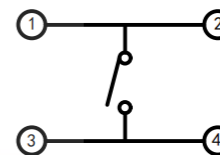

电路图

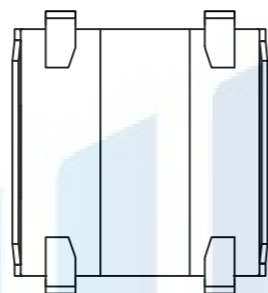
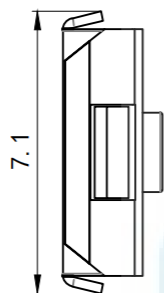
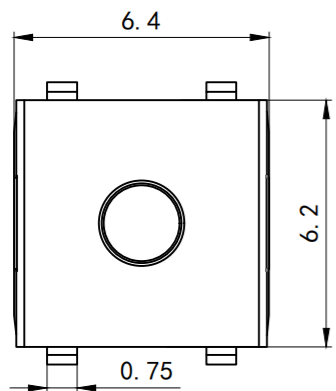
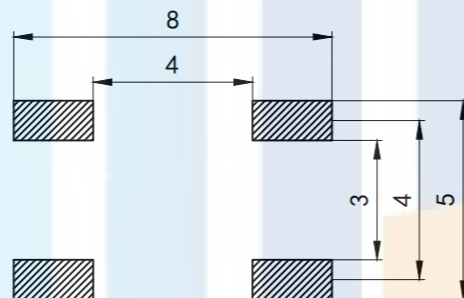
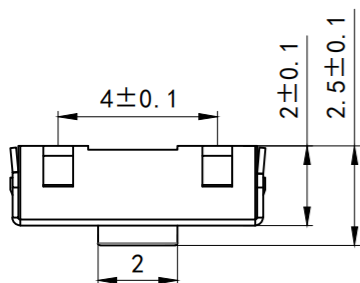

PCB. 焊接图

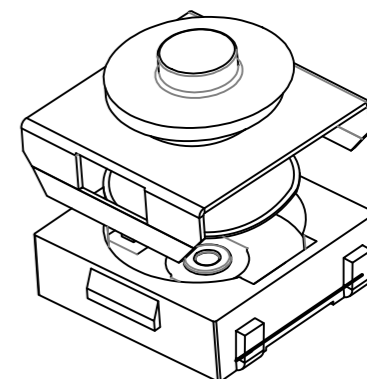
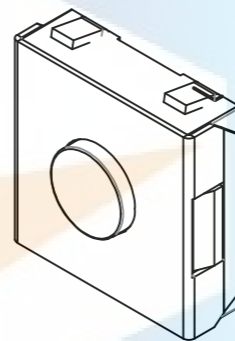

Main technical specifications:

1. Amount setting: 50mA DC12V
2. Contact resistance:  $\leq 50\text{m}\Omega$
3. Operation force:  $160\text{gf} \pm 50$  &  $260\text{gf} \pm 50$
4. Line length:  $0.25 \pm 0.2\text{mm}$
5. Insulation resistance:  $\geq 100\text{M}\Omega$
6. Electrical strength: 250V 50HZ 1Min.
7. Life span: 100,000 Cycles

TOLERANCE

X. XXX	$\pm 0.05$
X. XX	$\pm 0.15$
X. X	$\pm 0.20$
X.	$\pm 0.30$
ANGLE	$\pm 5.0^\circ$

PROTECTON

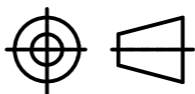

东莞市恒祺电子科技有限公司

Dongguan Hengqi Electronic Technology Co., Ltd

<https://www.hq-dz.com>

phone: 15812872448

TITLE:

轻触开关

PART NO: HQ-TS-E014

DRAWING NO: 6. 2\*6. 2\*H包脚

DRAWN:

DATE:

18-10-08

UNIT:  
mm

CHECKED:

DATE:

18-10-08

SCALE:  
FULL

APPROVED:

DATE:

18-10-08

SIZE:  
A4