

RoHS2.0  
Compliant

H
4.3
5.0

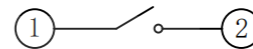

电路图

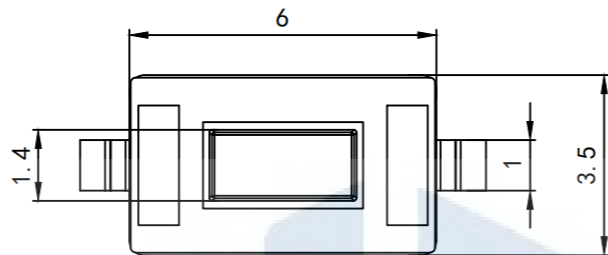
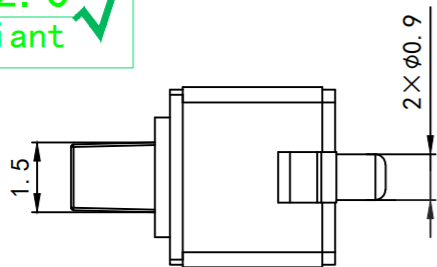
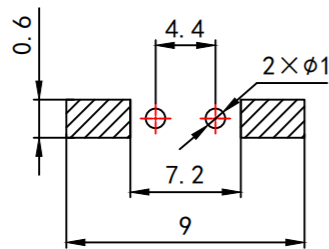
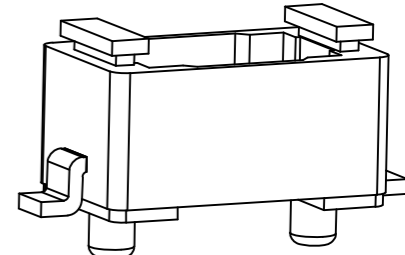
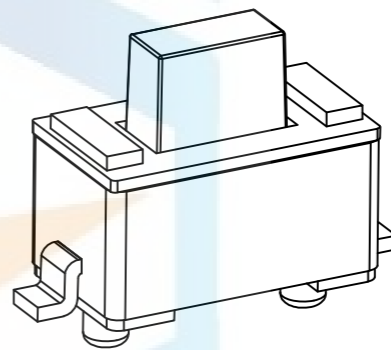
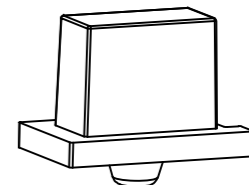

PCB. 焊接图

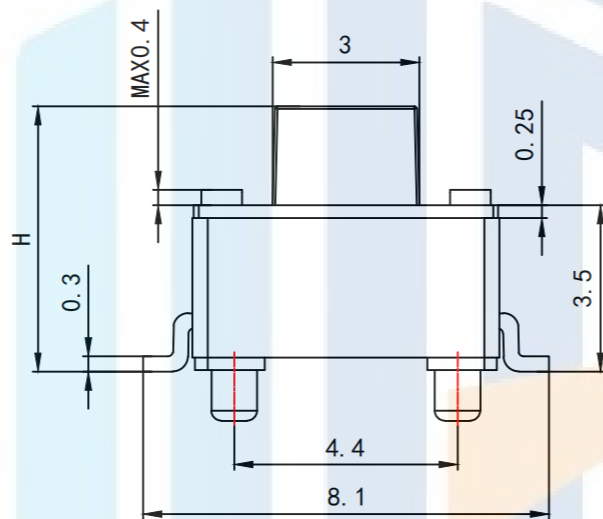

Key Technical Specifications:

1. Rating: 50mA DC12V
2. Contact resistance:  $\leq 100 \Omega$
3. Operating force:  $250 \pm 40 \text{gf}$
4. Itinerary:  $0.20 \pm 0.1 \text{mm}$
5. Insulation resistance:  $\geq 100 \text{M}\Omega$
6. Electrical strength: 250V 50HZ 1Min.
7. life span: 30,000 Cycles

<b>TOLERANCE</b> X. XXX $\pm 0.05$ X. XX $\pm 0.15$ X. X $\pm 0.20$ X. $\pm 0.30$ ANGLE $\pm 5.0^\circ$		东莞市恒祺电子科技有限公司 Dongguan Hengqi Electronic Technology Co., Ltd		
		<a href="https://www.hq-dz.com">https://www.hq-dz.com</a> phone: 15812872448		
<b>PROTECTON</b> 	TITLE: 轻触开关		PART NO: HQ-TS-B014	
	DRAWN:		DRAWING NO: 3*6*H正接带柱	
	CHECKED:	DATE: 18-10-08	UNIT: mm	SCALE: FULL
APPROVED:	DATE: 18-10-08	DATE: 18-10-08	SIZE: A4	