

RoHS2.0  
Compliant

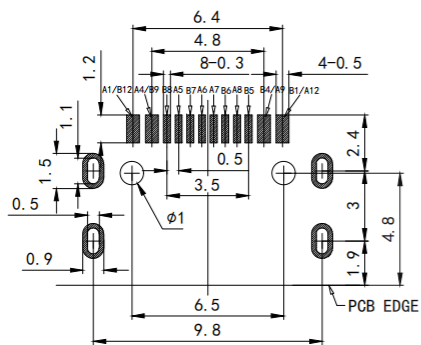

RECOMMEND P. C. B LAYOUT  
TOLERANCE UNSPECIFIED  $\pm 0.05$

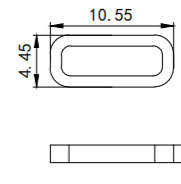
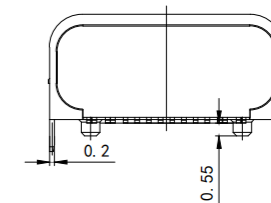
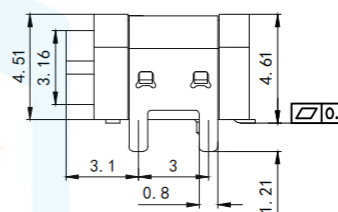
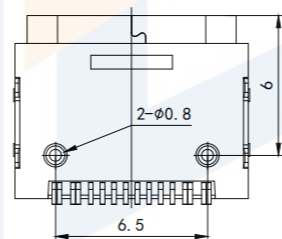
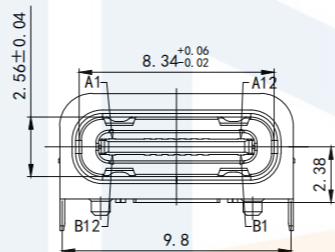
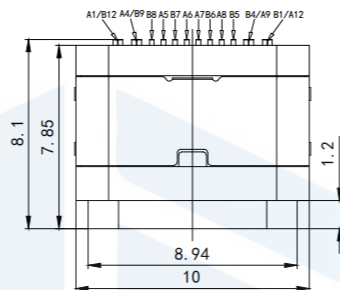

防水圈图示

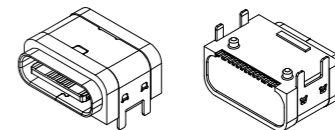

- NOTES:  
SPECIFICATION:
- CURRENT RATING: 3.0 A
  - VOLTAGE RATING: 3.0 V
  - VBUS & GND PINS AND OTHER PINS: 40mΩ/PIN MAX  
SHIELD: 50mΩ/MAX LLGR MAX. CHANGE OF ALL PINS: 10Ωm
  - INSULATION RESISTANCE: 100MΩ MIN
  - DIELECTRIC WITHSTAND VOLTAGE, AC 100V FOR 1MINUTE
  - INSERTION FORCE: 0.5~2.0kgf
  - UNMATING FORCE: 0.8~2.0kgf
  - DURABILITY: 10000 CYCLES
  - OPERATING TEMPERATURE: -35° C~+85° C
  - THE PEAK TEMPERATURE ON THE BOARD SHALL BE MAINTAINED FOR 10 SECONDS AT 210~230° C
  - WATERPROOF: IP-X7.

<b>TOLERANCE</b>			<b>东莞市恒祺电子科技有限公司</b>		
X. XXX	±0.05		Dongguan Hengqi Electronic Technology Co., Ltd		
X. XX	±0.15	<a href="https://www.hq-dz.com">https://www.hq-dz.com</a> phone:15812872448			
X. X	±0.20	<b>TITLE:</b>		<b>PART NO: TYPE-C16P-BS478FS</b>	
X.	±0.30	TYPE C 16P板上防水母座L=7.85		<b>DRAWING NO:10*4.51*7.85</b>	
ANGLE	±5.0°	4脚定位插板			
<b>PROTECTON</b>		<b>DRAWN:</b>	<b>DATE:</b>	<b>18-10-08</b>	<b>UNIT:</b> mm
		<b>CHECKED:</b>	<b>DATE:</b>	<b>18-10-08</b>	<b>SCALE:</b> FULL
		<b>APPROVED:</b>	<b>DATE:</b>	<b>18-10-08</b>	<b>SIZE:</b> A4