

RoHS2.0
Compliant

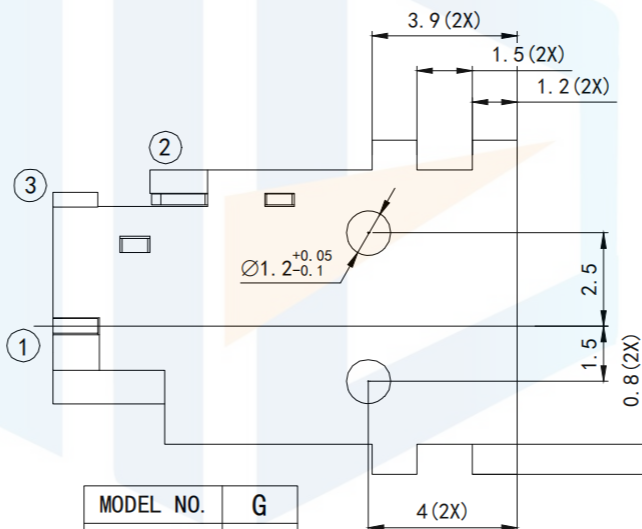

MODEL NO.	G
CENTER PIN	Ø1.65mm

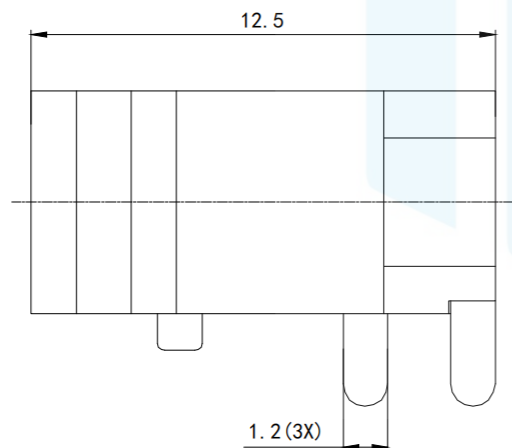
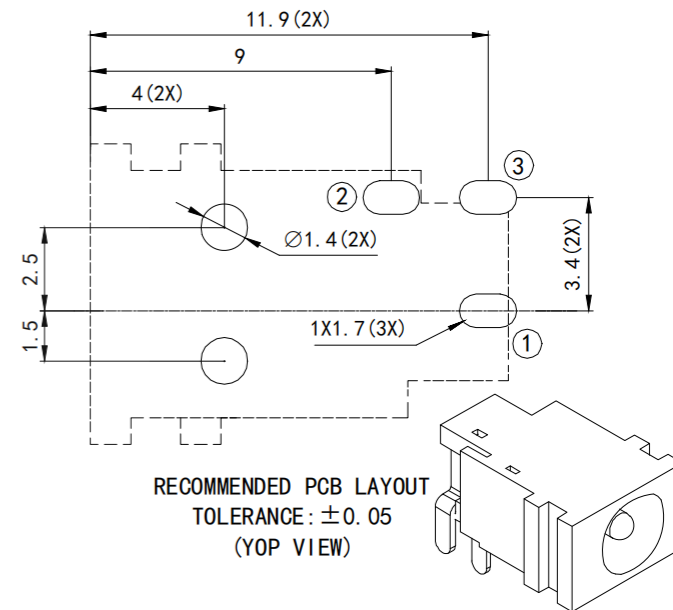
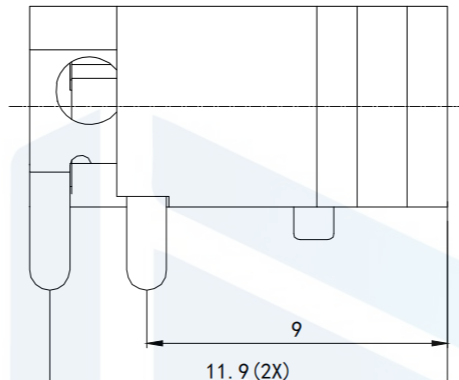
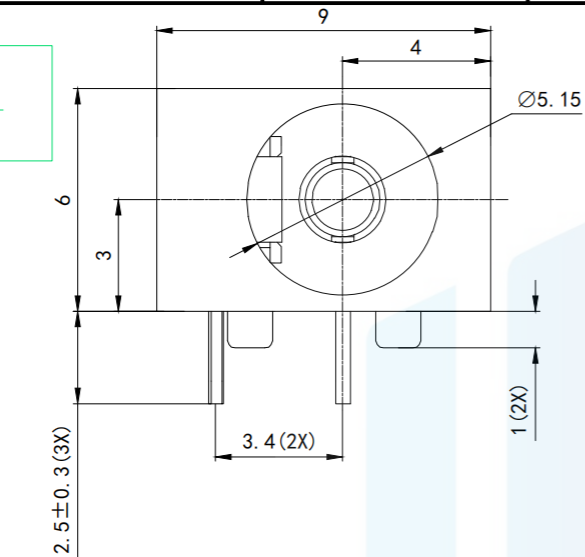
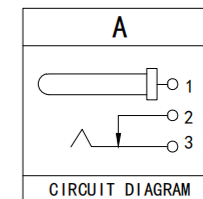
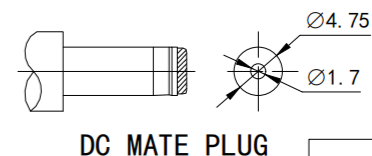

Technical requirements

1. Rated load: DC 30V 0.5A
2. Contact resistance: $\leq 0.03 \Omega$
3. Insulation resistance: $\geq 100 \Omega$ DC250V
4. Withstand voltage: AC 500V(50Hz)/min
5. Insertion force: 3~20N
6. Mechanical life: 5000 times
7. Operation temperature range: $-30^{\circ}\text{C} \sim 70^{\circ}\text{C}$

TOLERANCE

X. XXX	±0.05
X. XX	±0.15
X. X	±0.20
X.	±0.30
ANGLE	±5.0°

PROTECTON

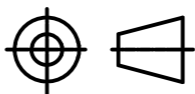

东莞市恒祺电子科技有限公司

Dongguan Hengqi Electronic Technology Co., Ltd

<https://www.hq-dz.com>

phone: 15812872448

TITLE:

DC电源插座

PART NO: DC-049

DRAWING NO: 12.5*9*6

DRAWN:

DATE:

18-10-08

UNIT:
mm

CHECKED:

DATE:

18-10-08

SCALE:
FULL

APPROVED:

DATE:

18-10-08

SIZE:
A4