

RoHS2.0
Compliant

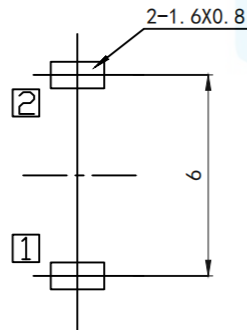
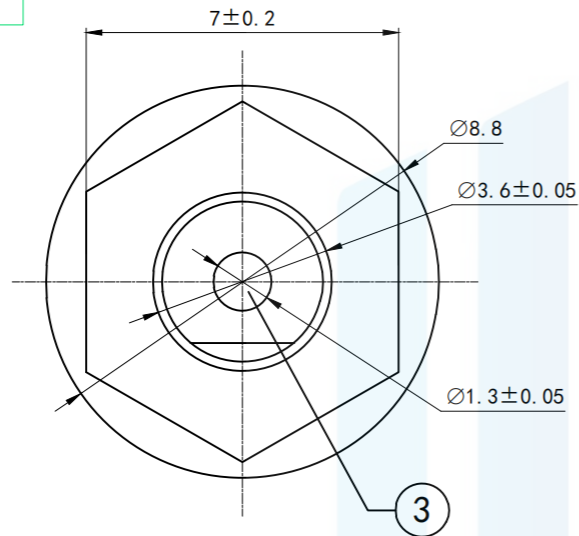

PCB HOLES (SOP VIEW) T=1.6mm
NOTE: GENERAL TOLERANCE: ±0.05mm

Technical requirements

1. Rated load: DC 30V 0.5A
2. Contact resistance: ≤0.03 Ω
3. Insulation resistance: ≥100 Ω DC250V
4. Withstand voltage: AC 500V (50Hz)/min
5. Insertion force: 3~20N
6. Mechanical life: 5000 times

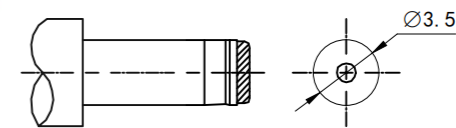
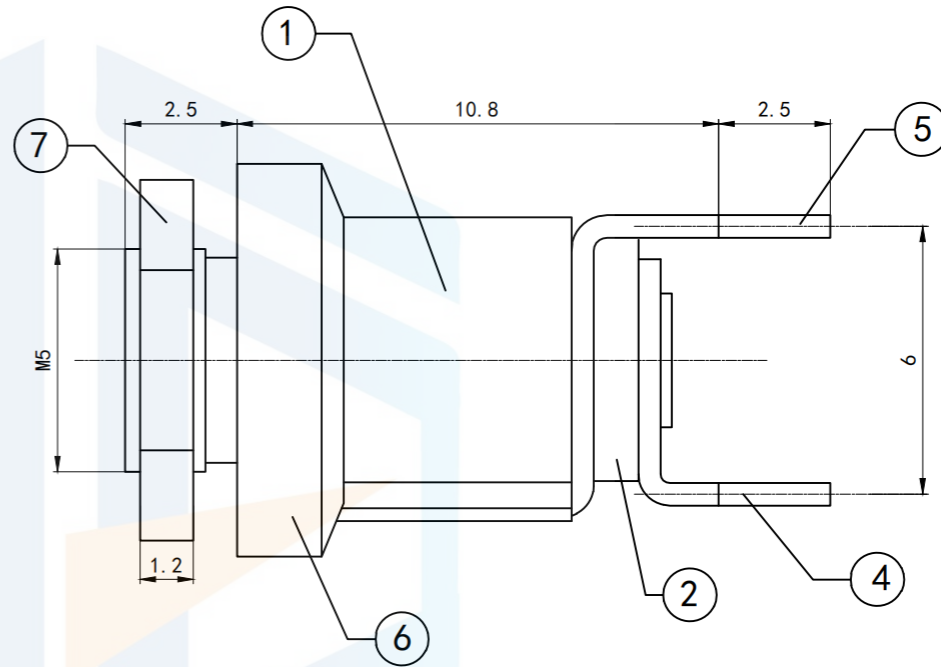

DC MATE PLUG

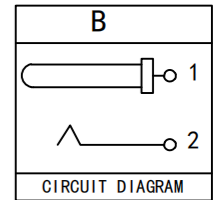

CIRCUIT DIAGRAM

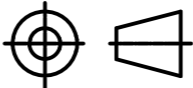
TOLERANCE X. XXX ±0.05 X. XX ±0.15 X. X ±0.20 X. ±0.30 ANGLE ±5.0°	 东莞市恒祺电子科技有限公司 Dongguan Hengqi Electronic Technology Co., Ltd	https://www.hq-dz.com		phone: 15812872448	
		TITLE: DC电源插座		PART NO: DC-035	
PROTECTON 	DRAWN:		DATE:	18-10-08	UNIT: mm
	CHECKED:		DATE:	18-10-08	SCALE: FULL
	APPROVED:		DATE:	18-10-08	SIZE: A4