

RoHS2.0
Compliant

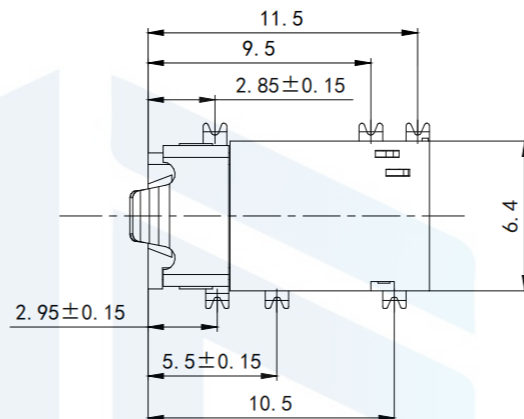

P. C. B LAYOUT
TOP VIEW

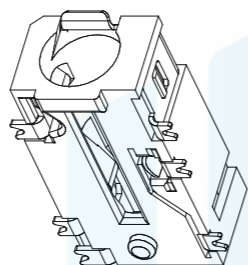
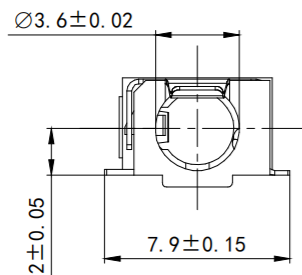
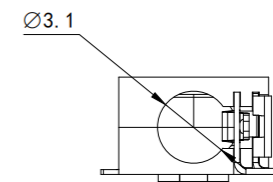
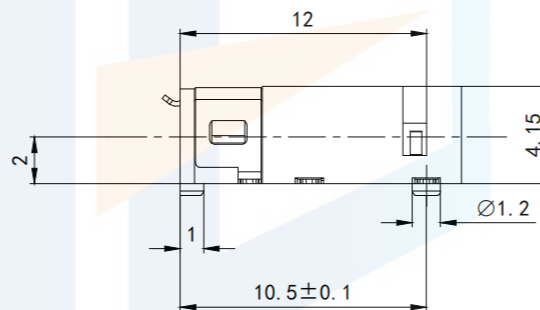
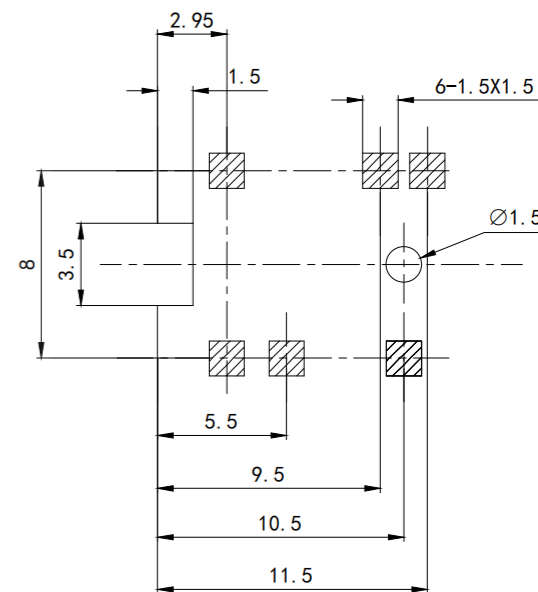

SCHEMATIC

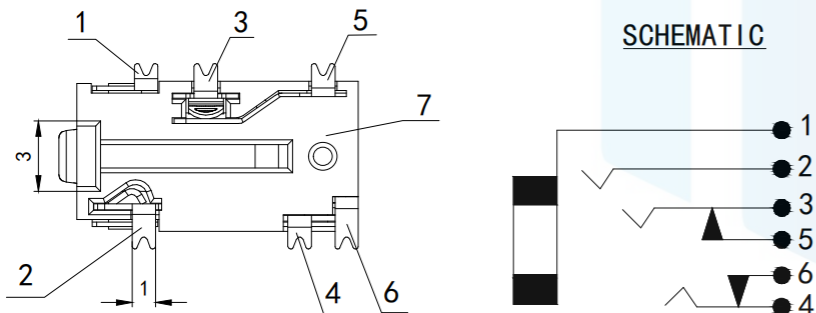

SBECIFICATION

1. Rating ?DC 30V 0.5A?
2. Contact resistance?<0.030?
3. Insulation resistance??100MΩ (DC250V)?
4. Withstand voltage?500VAC ?
5. Insertion and extraction force?3-20N
6. life test?5,000 cycles?

TOLERANCE

X. XXX	±0.05
X. XX	±0.15
X. X	±0.20
X.	±0.30
ANGLE	±5.0°

PROTECTON

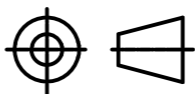

东莞市恒祺电子科技有限公司

Dongguan Hengqi Electronic Technology Co., Ltd

<https://www.hq-dz.com>

phone:15812872448

TITLE:

耳机插座

PART NO:PJ-342F

DRAWING NO:12*6.4*4

DRAWN:

DATE:

18-10-08

UNIT:
mm

CHECKED:

DATE:

18-10-08

SCALE:
FULL

APPROVED:

DATE:

18-10-08

SIZE:
A4